

Esquema Hidráulico / Uso Simultâneo

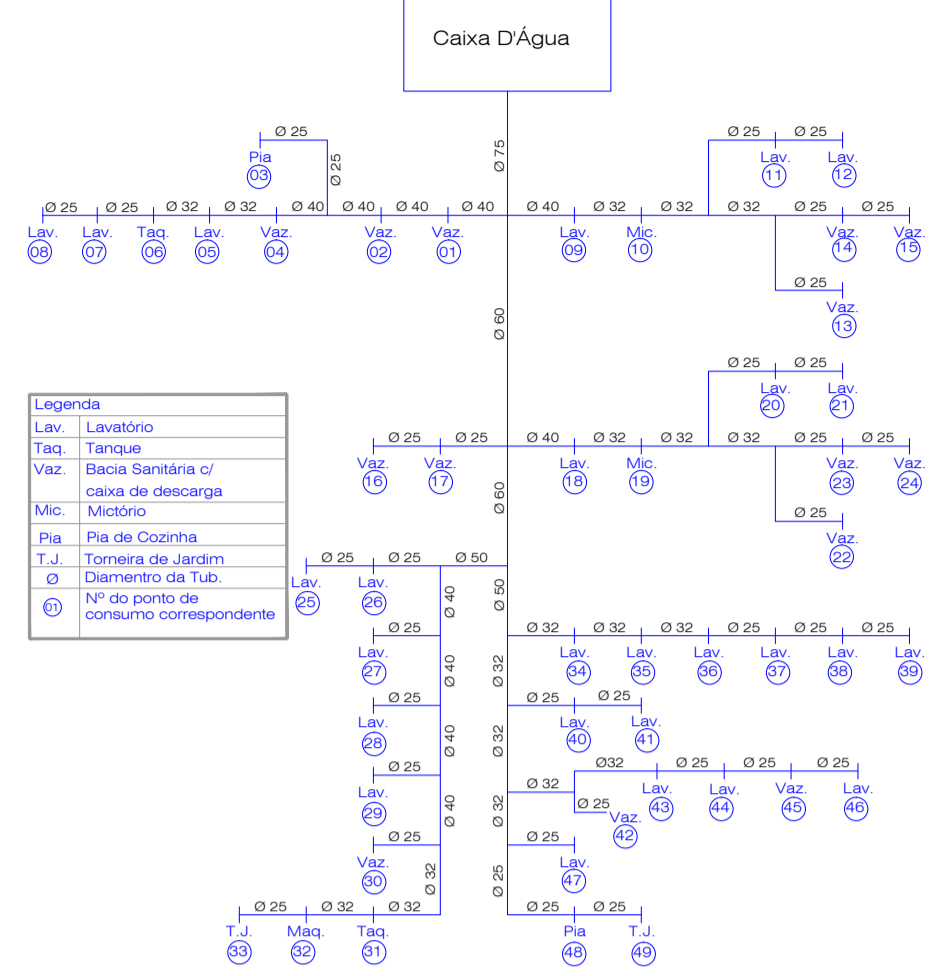

Legenda Hidraulica

Simbologia	
AF	PONTO OU PRIMADA DE ÁGUA FRIA - DIÂMETRO mm
RG	REGISTRO
AF 25 Ø 25	TUBULAÇÃO DE ÁGUA FRIA - DIÂMETRO mm
CV, LV, RL, RD, VL	CHUVEIRO, LAVATÓRIO, BACIA SANITÁRIA, TANQUE, MAQ. LAVAR
T.J.	TORNEIRA DE JARDIM

Legenda	
Lav	Lavatório
Tan	Tanque
Vaz	Bacia Sanitária ou caixa de descarga
Mic	Mictório
Pla	Placa de Cozinha
T.J.	Torneira de Jardim
Ø	Diâmetro da Tub.
Nº	Nº do ponto de consumo correspondente

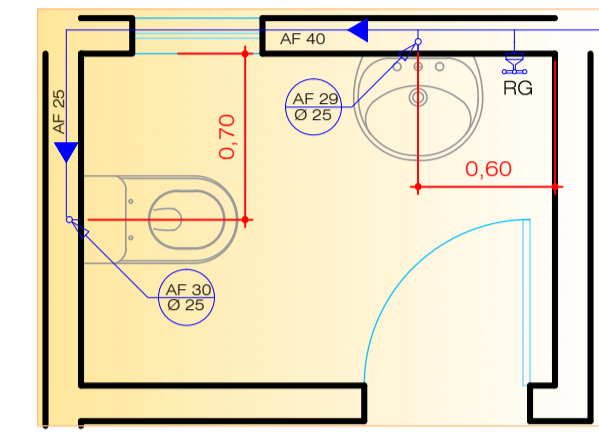

Detalhe Bwc

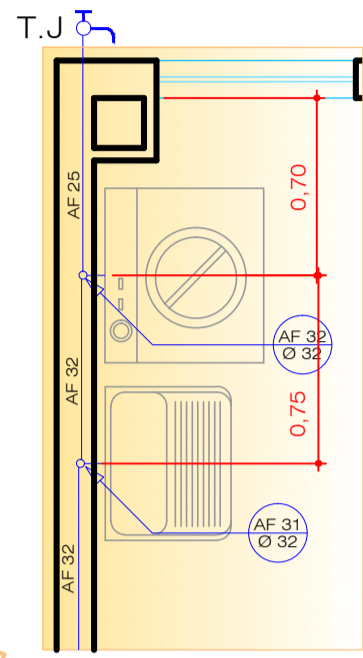

Detalhe Lavanderia

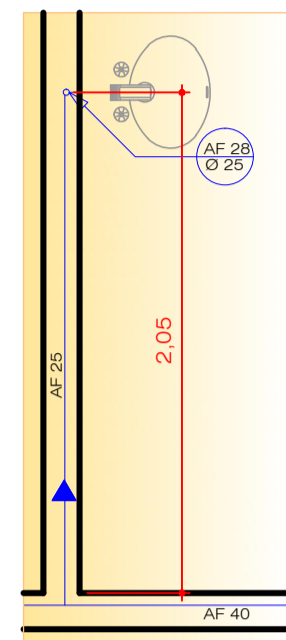

Detalhe Sala de Vacinação

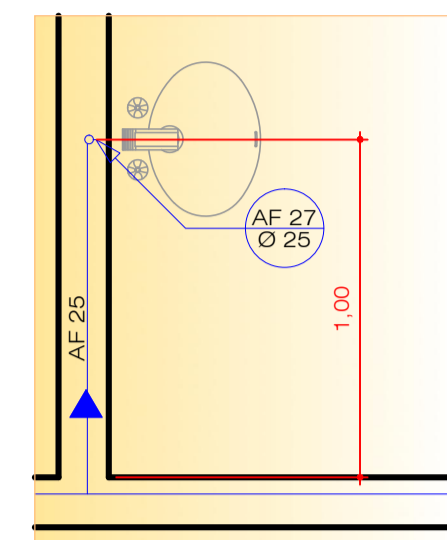

Detalhe Sala de Exames

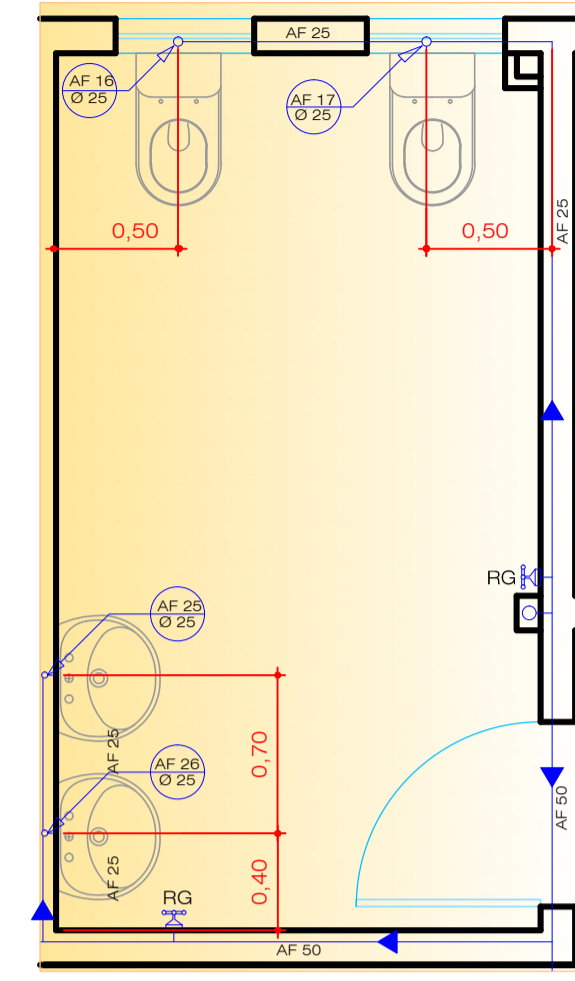

Detalhe Bwc Fem.

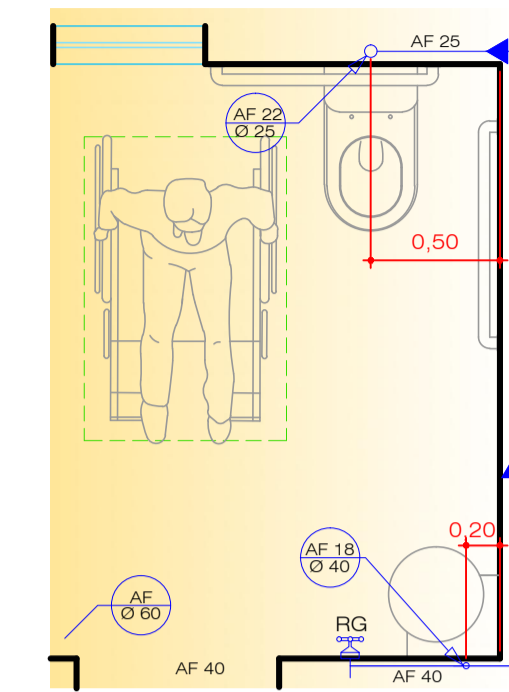

Detalhe Bwc P.N.E.

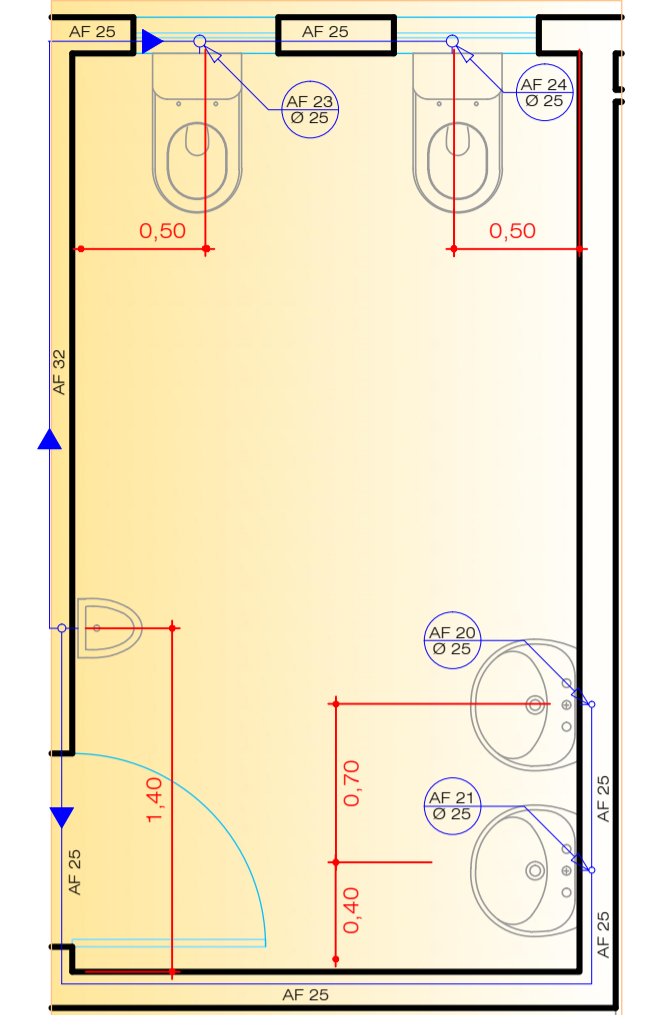

Detalhe Bwc Masc.

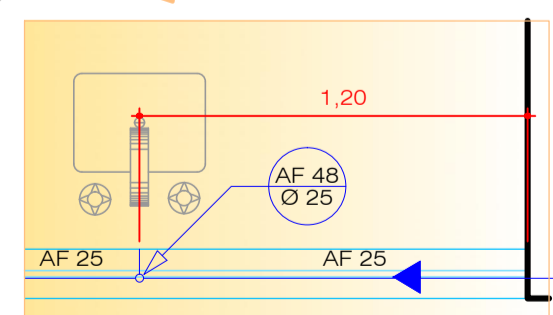
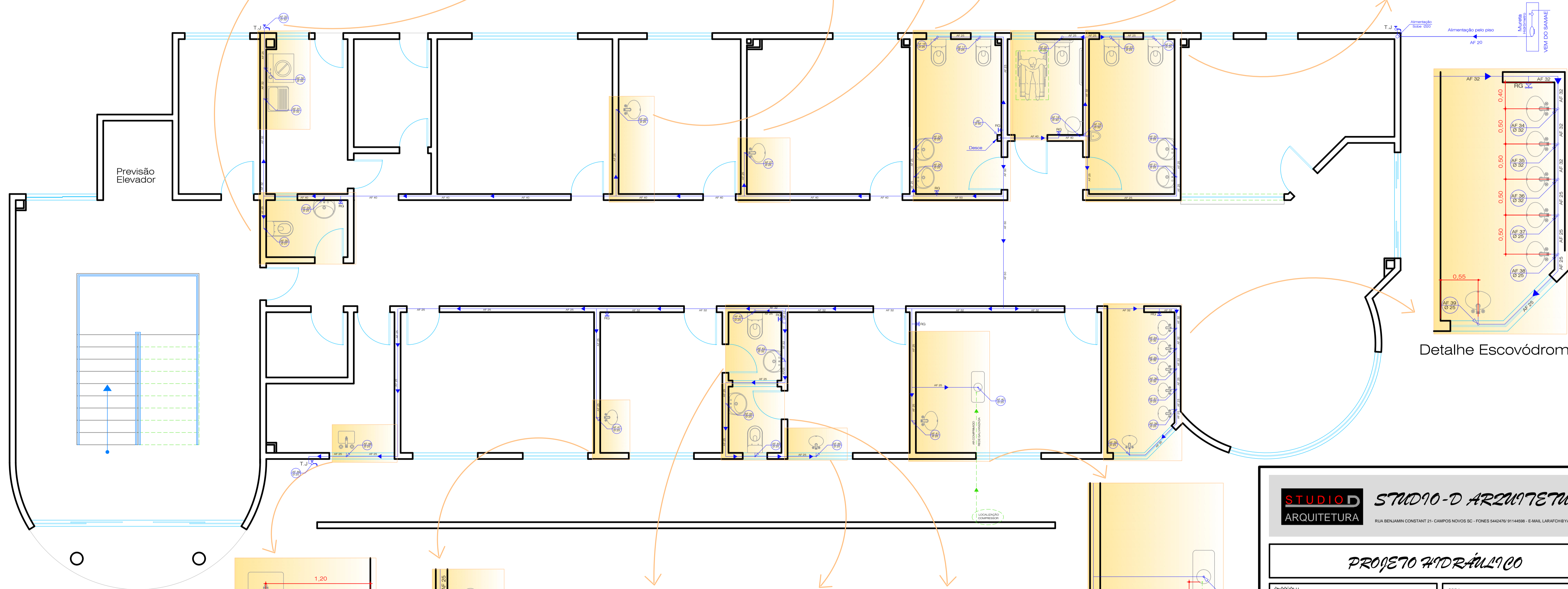

Detalhe Copa

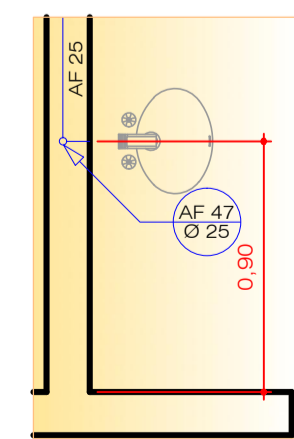

Detalhe Consultório Médico

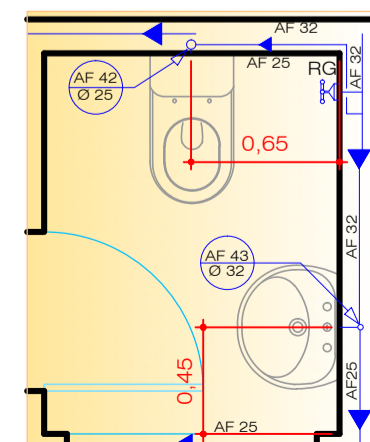

Detalhe Bwc

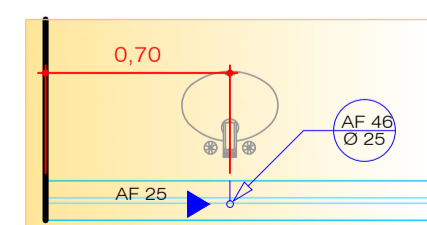

Detalhe Sala de Primeiros Socorros

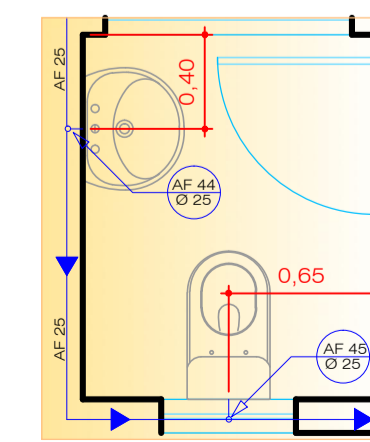

Detalhe Bwc

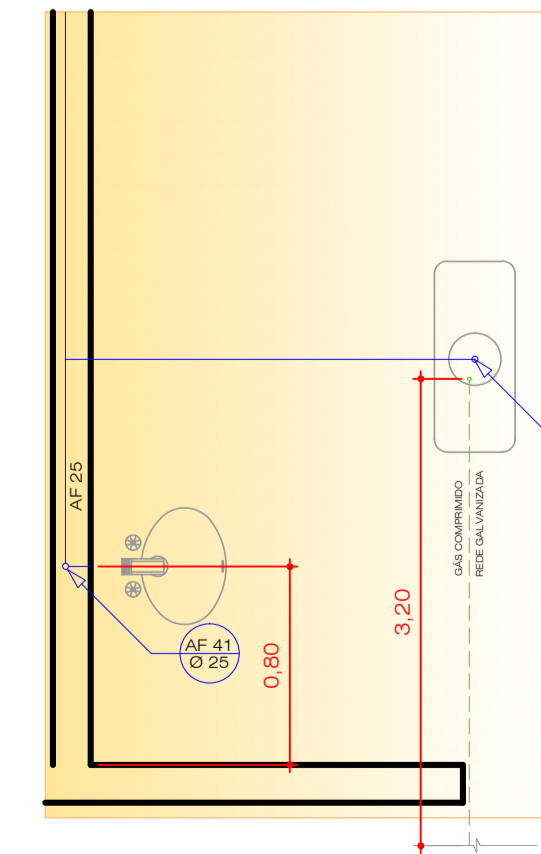

Detalhe Consultório Odontológico

Planta de Instalação Hidráulica - Pav. Térreo
Esc. 1:50

STUDIO D ARQUITETURA
RUA BENJAMIN CONSTANT 21 - CAMPOS NOVOS SC - FONES 5442476/ 91144598 - E-MAIL LARA.FCH@YAHOO.COM.BR

PROJETO HIDRÁULICO

OBRA: Av. Caetano Belincanta Neto esq. com a Rua Vergílio Antunes

RESERVADO CARIMBO E ASSINATURA

RESERVADO CARIMBO E ASSINATURA

LARA FERNANDA CHIAMOLERA - Arquiteta e Urbanista CREA: 062778-1

PREFEITURA MUNICIPAL DE CAMPOS NOVOS

DATA: Novembro/2011
ESCALA: Indicada

PRANCHA: 02/02