

Vigas dos pavimentos Bombas, Barilete e Cobertura

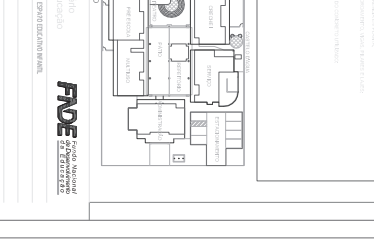

Vigas dos pavimentos Reservatório 1 e 2

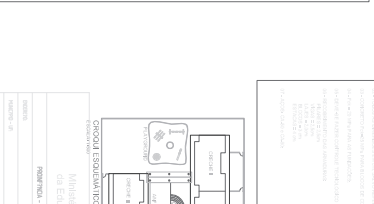
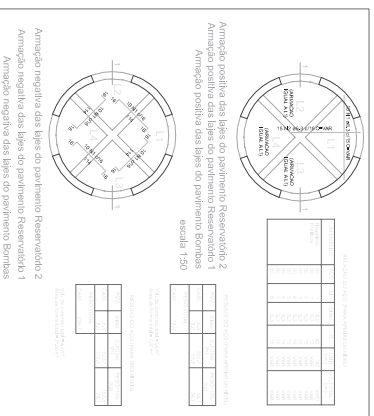
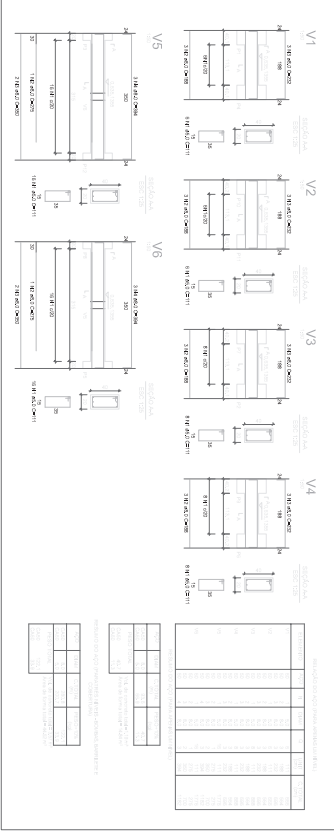
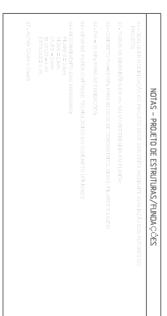
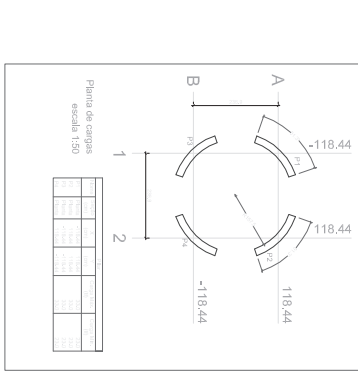
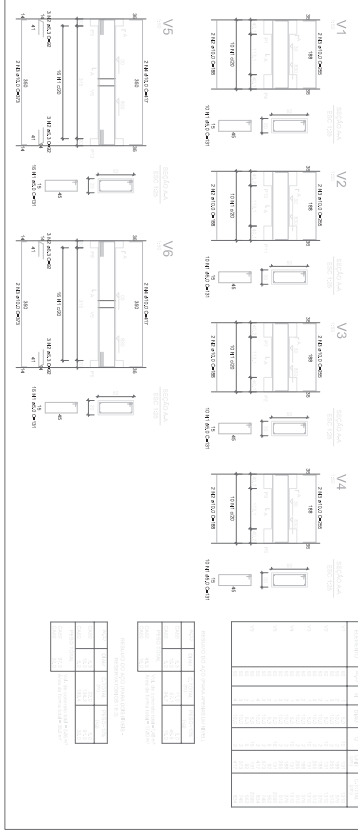

FIDE Engenharia de Edificações
 Rua ...
 ...

PROJETO
ESTRUTURAL
 ...
 ...