

V101

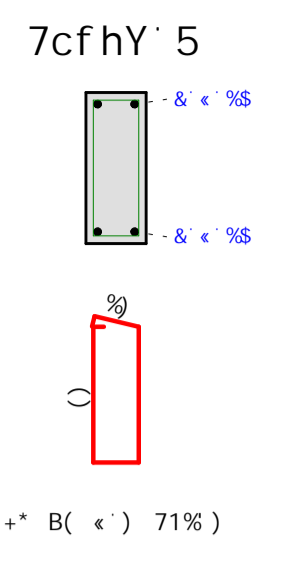

V102

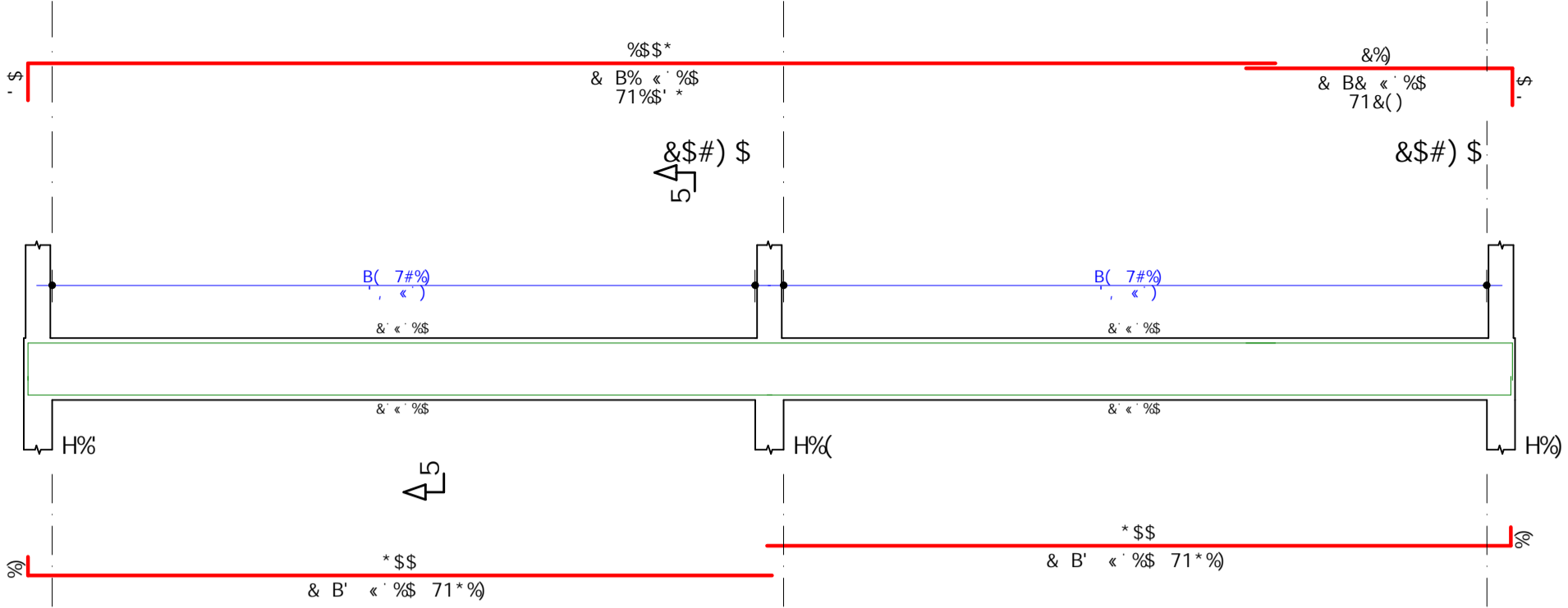
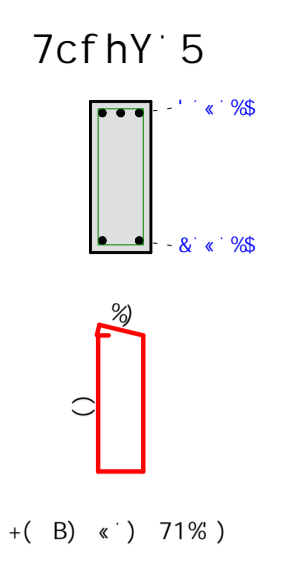
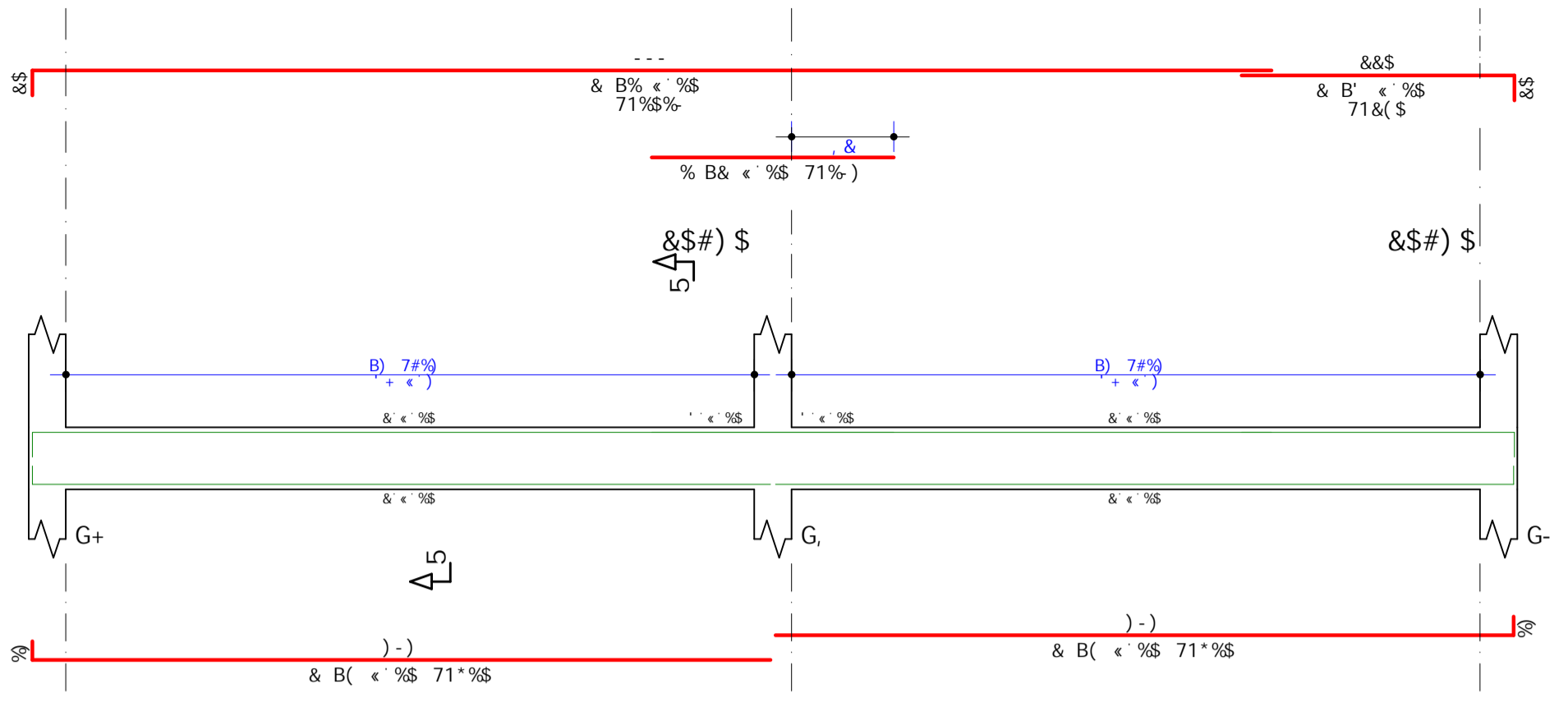

V103

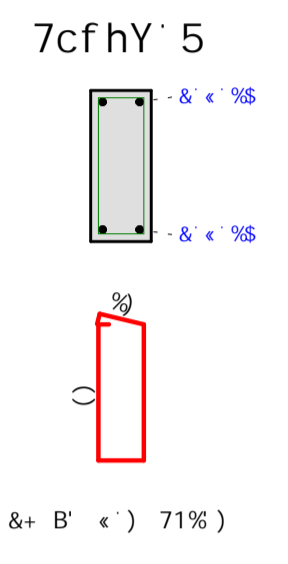
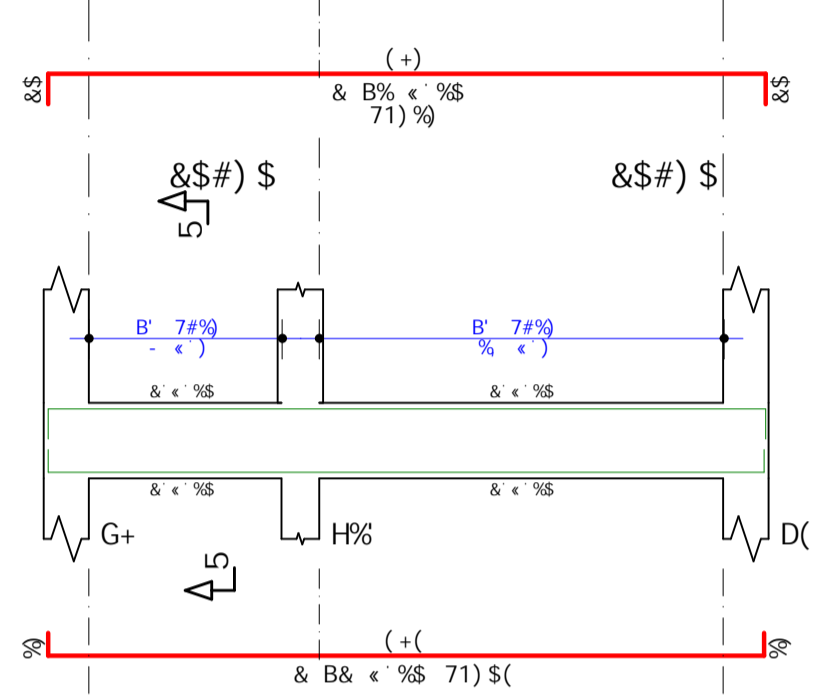

V105

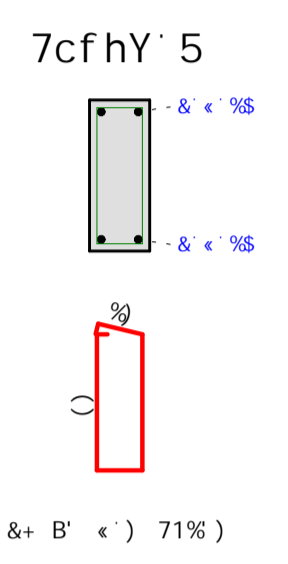
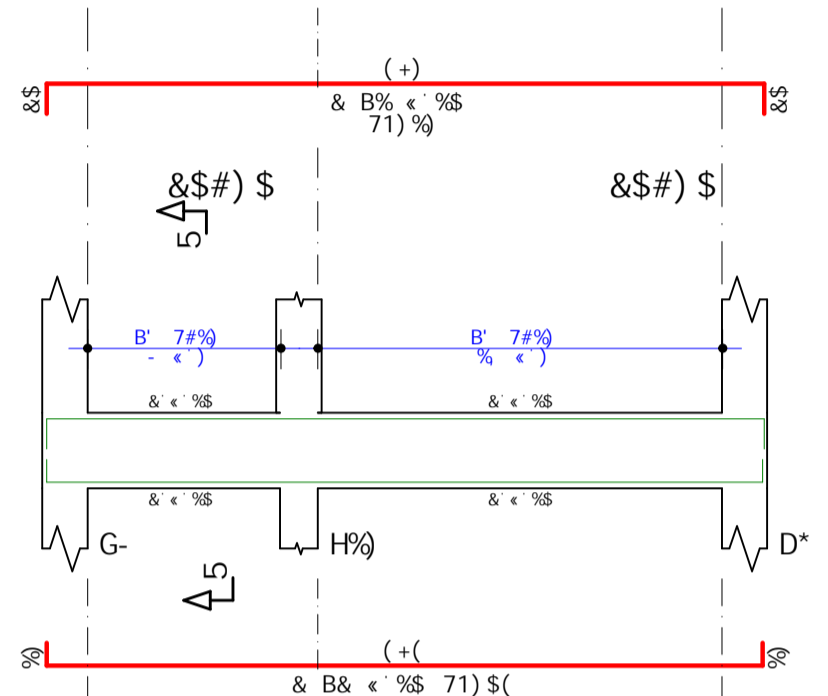

V104

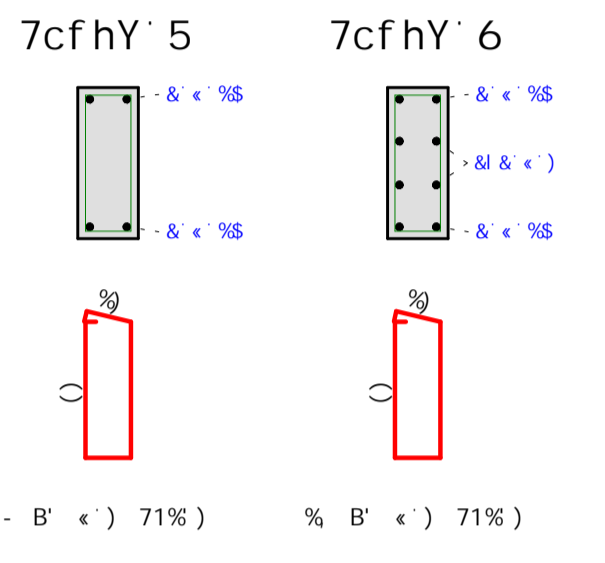
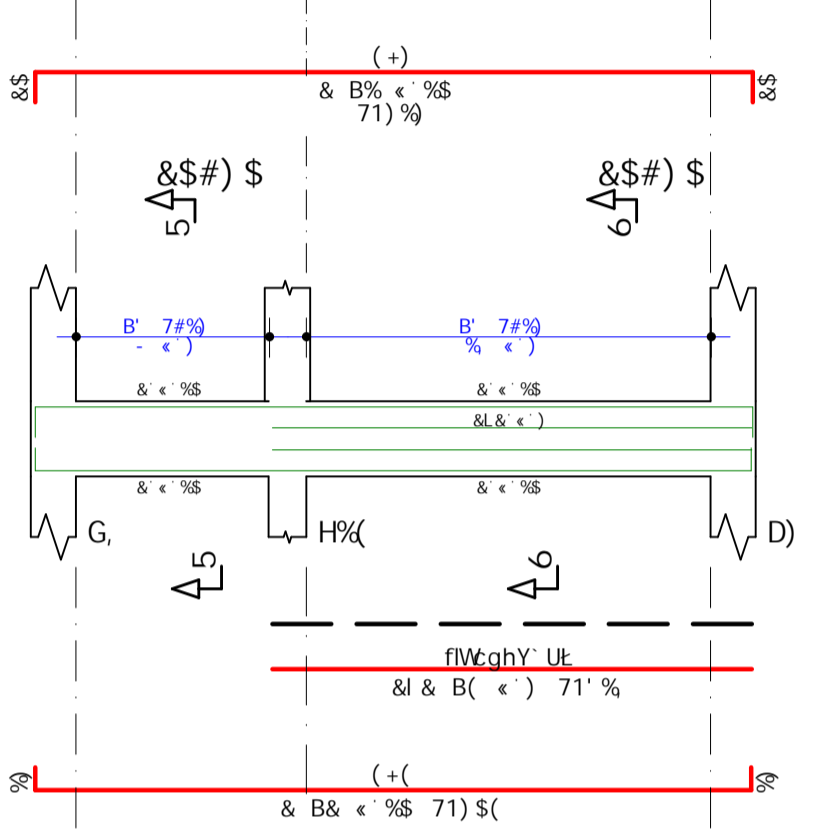

5uC	DCG	6=H	EI 5BH	7CADF=A9BHC	IB=H	HCH5@
aa				Va	Va	Va
J%\$%)\$5	%	%	&	%\$	&S+&
)\$5	&	%	%	&	&(\$	(-\$
)\$5	(%	%	(%	&(\$
)\$5	(%	%	(%	&(\$
J%\$&)\$5	%	%	&	%\$	&S
)\$5	&	%	%	&	&(\$	(-\$
)\$5	(%	%	(%	&(\$
)\$5	(%	%	(%	&(\$
J%\$')\$5	%	%	&	%\$	&S
)\$5	&	%	%	&	&(\$	(-\$
)\$5	(%	%	(%	&(\$
)\$5	(%	%	(%	&(\$
J%\$()\$5	%	%	&	%\$	&S
)\$5	&	%	%	&	&(\$	(-\$
)\$5	(%	%	(%	&(\$
)\$5	(%	%	(%	&(\$
J%\$))\$5	%	%	&	%\$	&S
)\$5	&	%	%	&	&(\$	(-\$
)\$5	(%	%	(%	&(\$
)\$5	(%	%	(%	&(\$
J%\$*)\$5	%	%	&	%\$	&S
)\$5	&	%	%	&	&(\$	(-\$
)\$5	(%	%	(%	&(\$
)\$5	(%	%	(%	&(\$

F9GI AC 89 5uC			
5uC	6=H	7CADF	D9GC
aa	a		Z
)\$5)))
)\$5	&))
)\$5	())
)\$5	())
DYgc HchU	*5\$ 1		
DYgc HchU	\$5 1		Z

V201

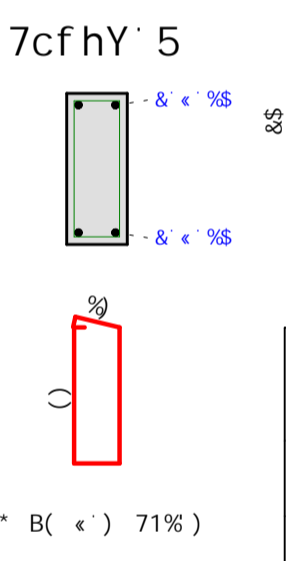
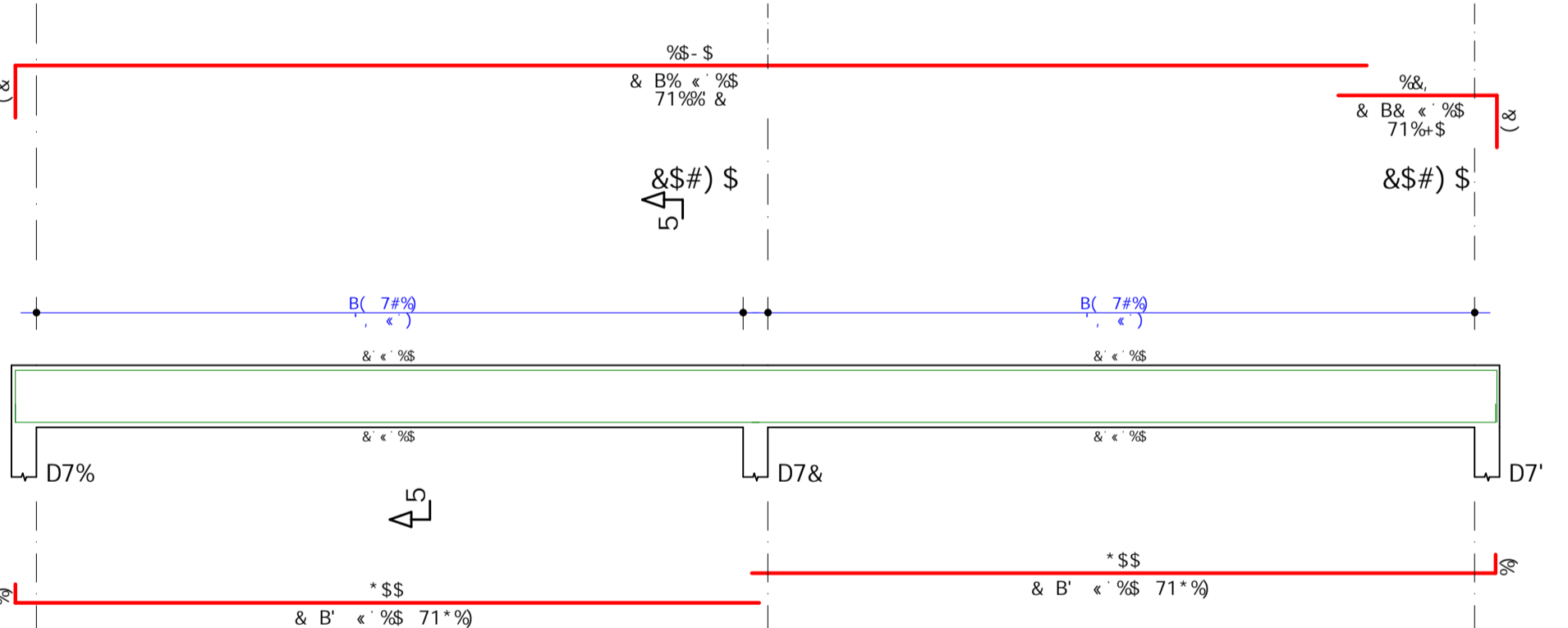

V202

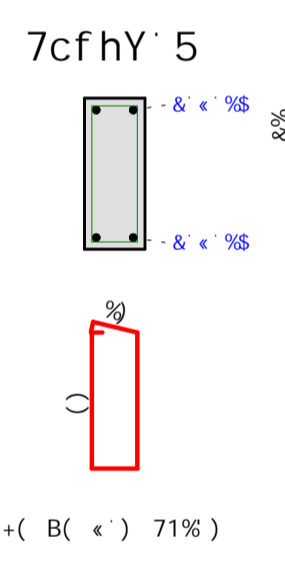
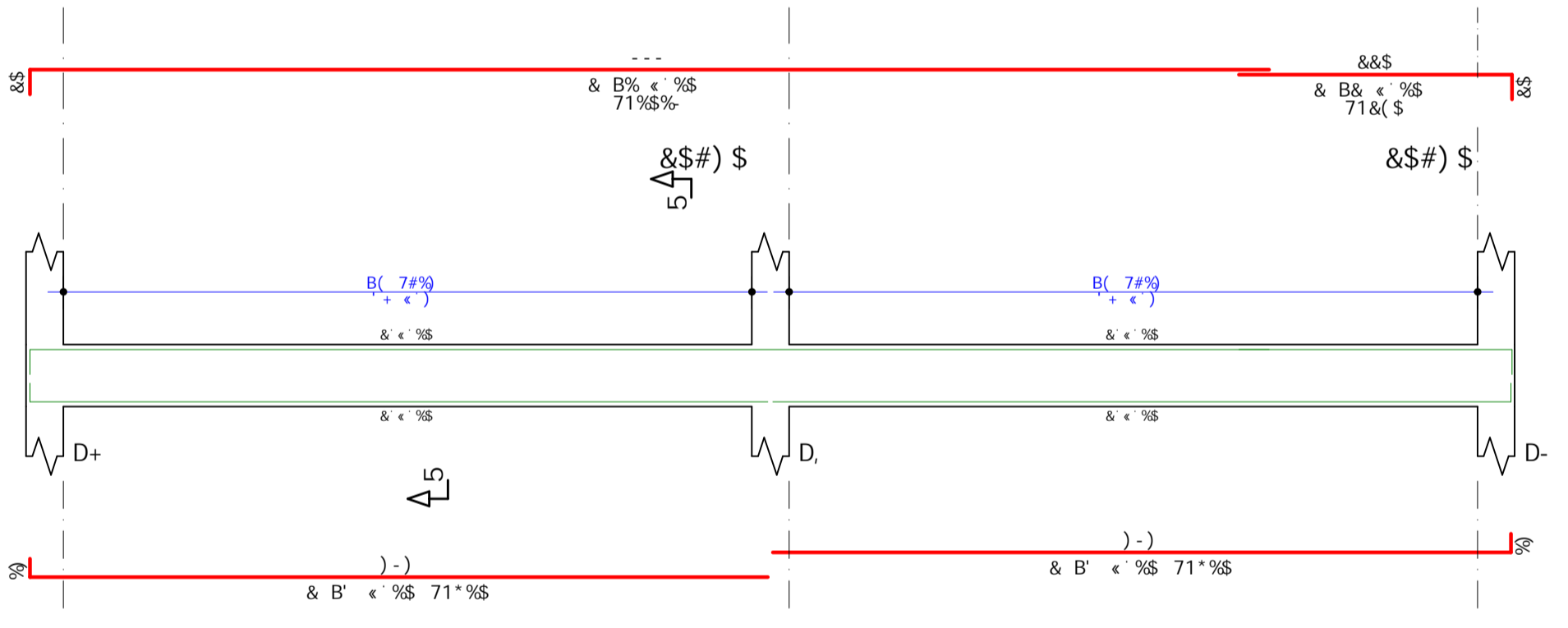

V206

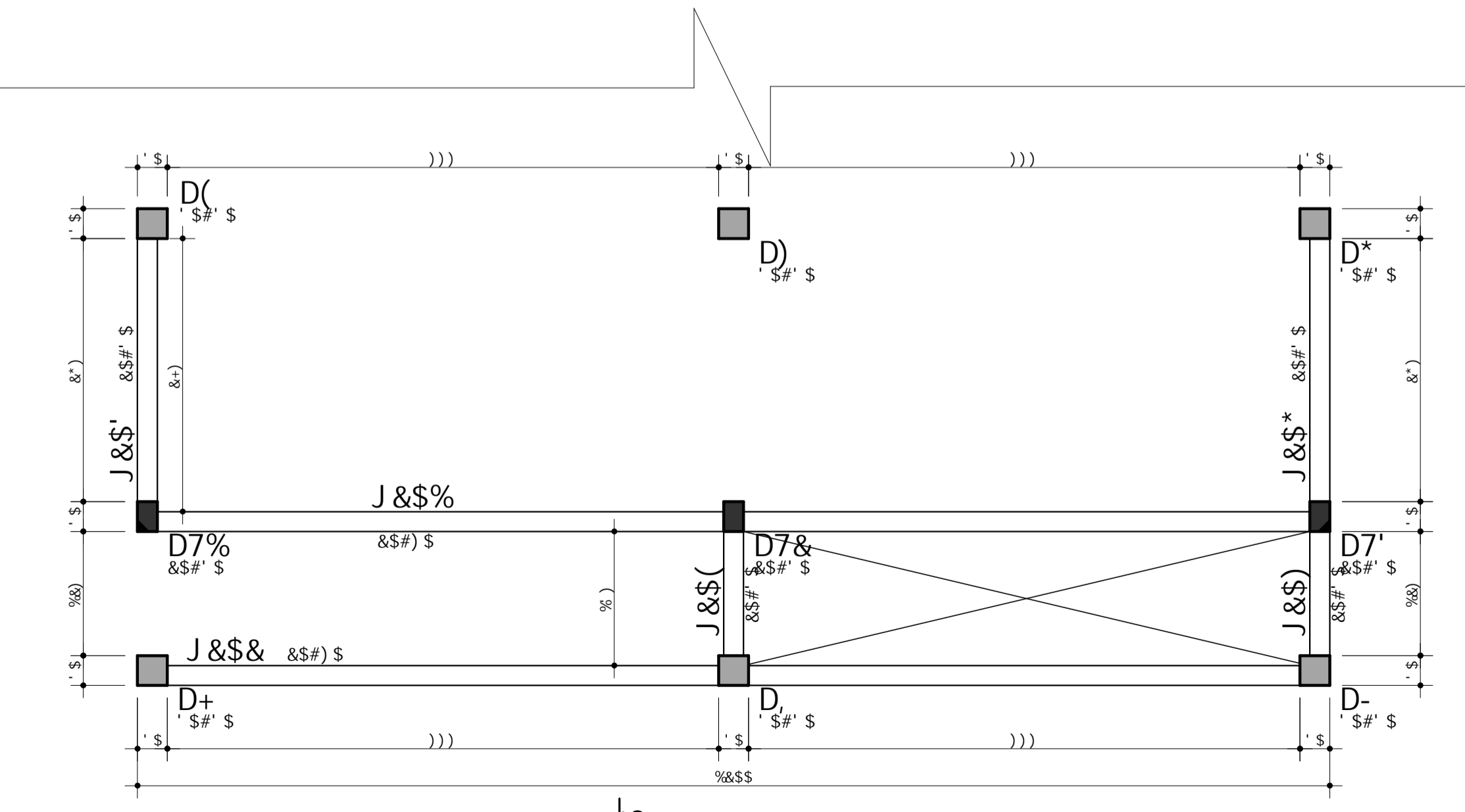
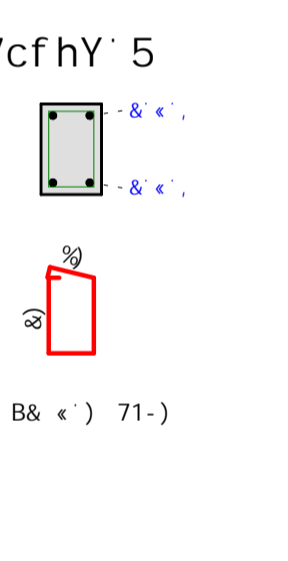
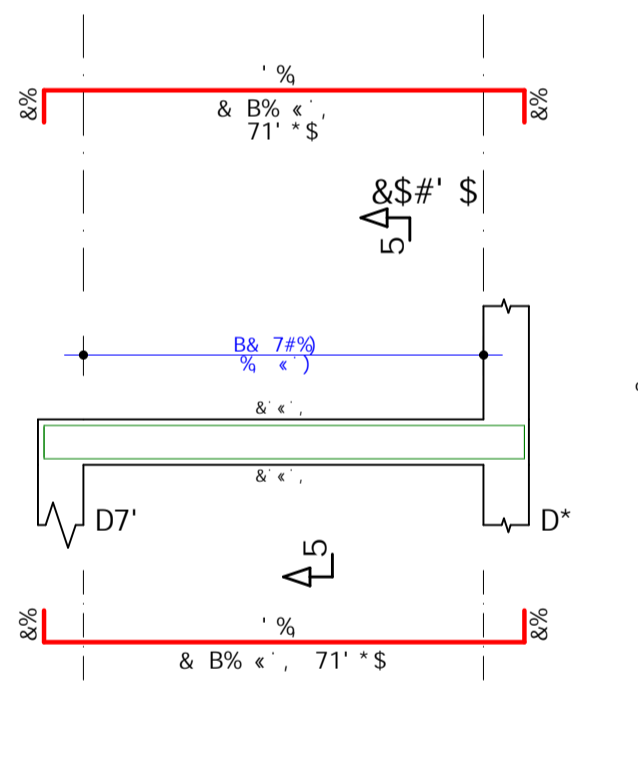

V203

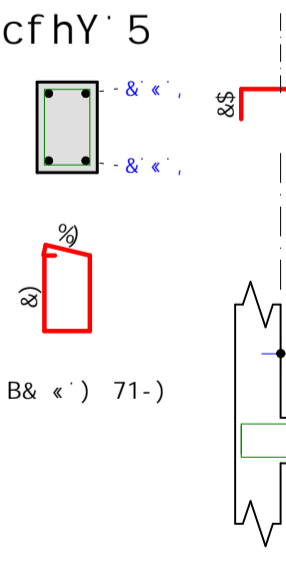
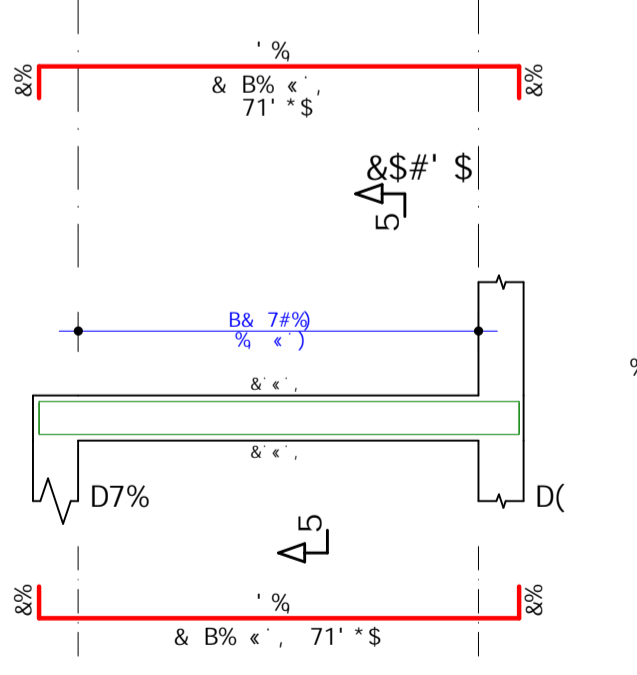

V204

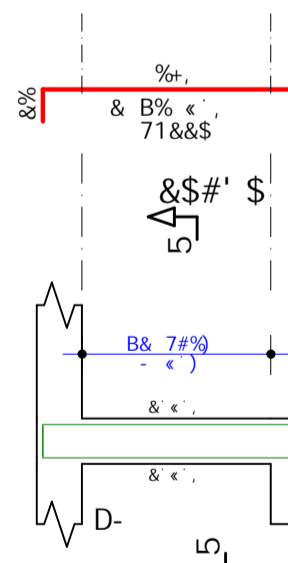
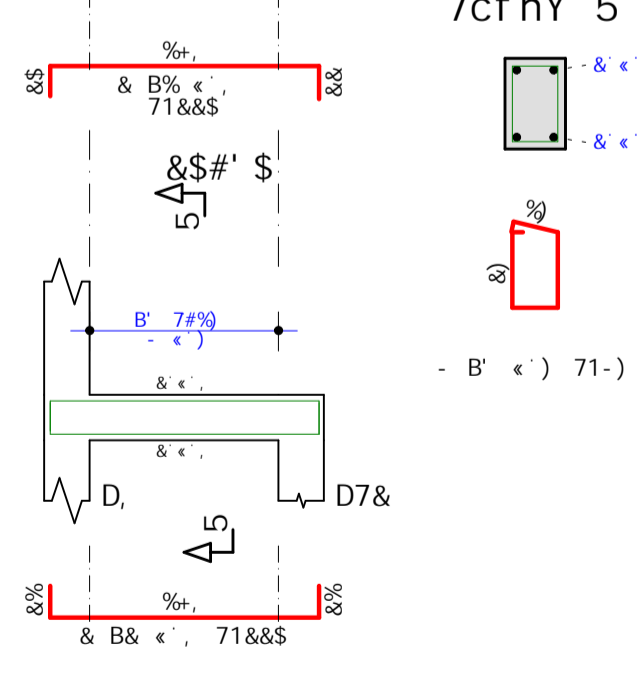

V205

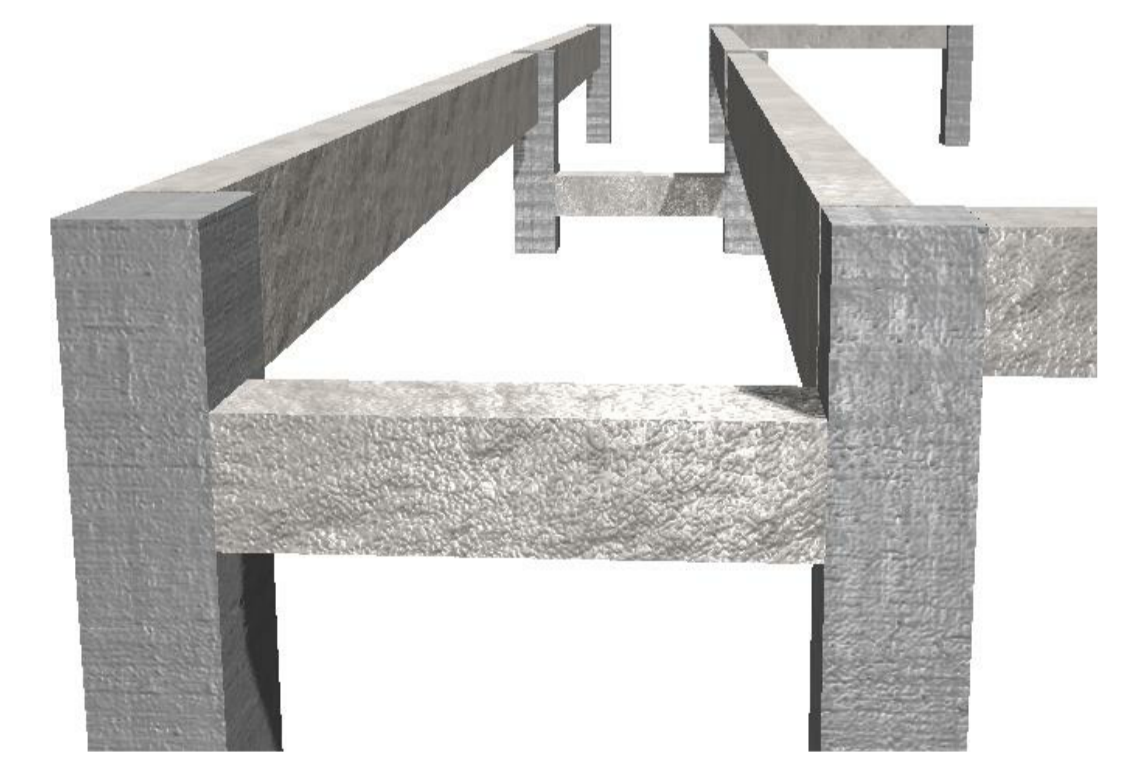
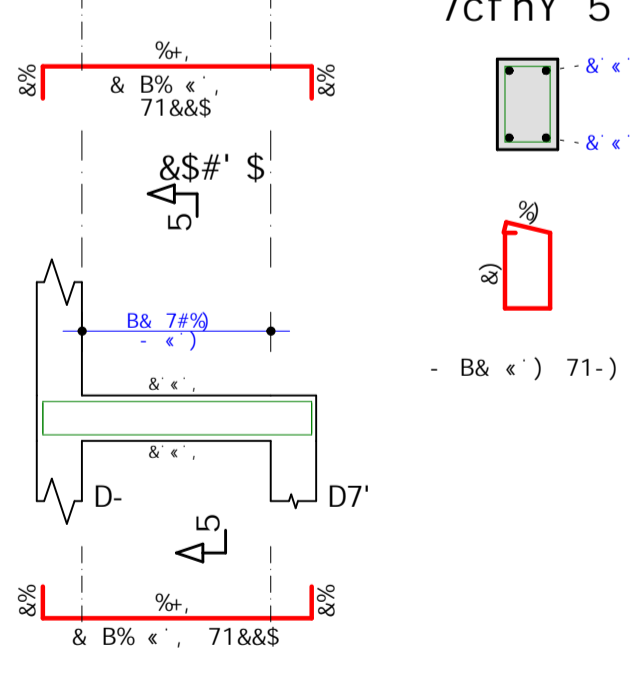

D@5BH5' 89' : CFA5' fl6U' Xf UaY' Gi dYf] cf t
9G75@5. %#) \$

Campos Novos

DF9: 9=HI F5' AI B=7=D5@ 89' 75ADCG' BCJCG' flG7L
 F1.5 9.006-7.004-2' 8' 1' 2009-11-09 04:11:13-1455

G97F9H5F=5' AI B=7=D5@ 89' HF5BGDCFH9G2' C6F5G' 9' I F65B=GAC
 89D5FH5A9BHC' 89' 9B; 9B<5F=5

COFE: 5AD@=5uEC' @5F' 8CG' A9B=BCG

DFC=9RC: 9GHFI HI F5@

5GGI BHC: J=5G %\$S' flBaJ9@' : I B85uEC' GI D9F=CFL
 J=5G %\$S' flBaJ9@' 65@9F 5A9' GI D9F=CFL

BSHL: BCJ 9A6FC#&S&S%

F1.5' 5BAG=C' HCG75B2' 65=FFC' G5BHC' 5BHB=C2' 75ADCG' BCJCG' I' G7

768=C' 758' 8889PC6F 5GPG97' GC7=5@F

F9GD' H78-7C

DF95' 7CBG#1 885

%(*2(\$ a

9C7585

=BB=7585

89G9B=C

9BA=@GCB >' F'

G98J-C: 589L 589F 9' N87585FC
 DF9: 9=HI AI B=7=D5@